

# Data Sheet



Article number: 025799300080

Description: Norma Connect pipe coupling  
GRIP E W5 Ø=80,0 EPDM, 16 bar

## Measures

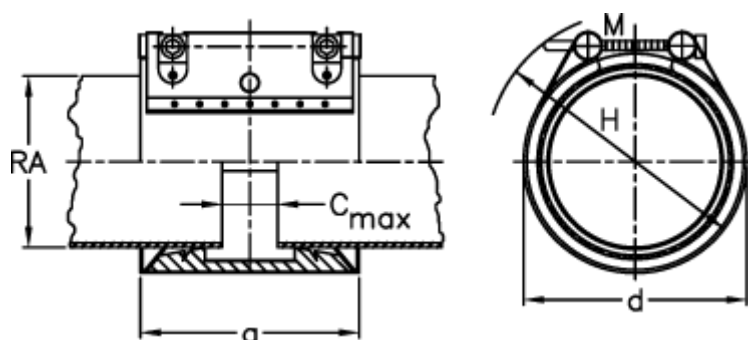

a	= 98
C max with insertion band	= 25
d	= 100
H	= 120
M (screw)	= M10
Nominal pressure (bar)	= 16
RA	= 80
RA min-RA max	= 79,0-80,8

Weight a piece = 1.25